

J 1247
0,448 Kg/m

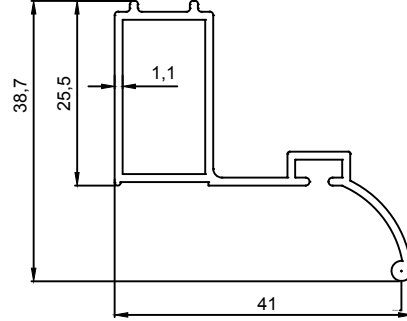

J 1248
0,365 Kg/m

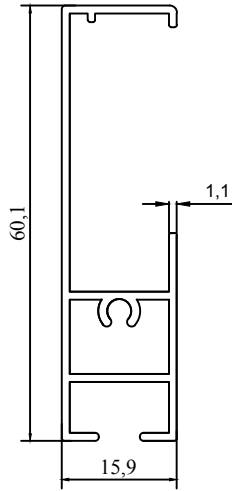

J 1249
0,446 Kg/m

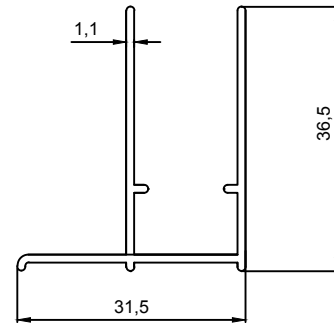

J 1250
0,319 Kg/m

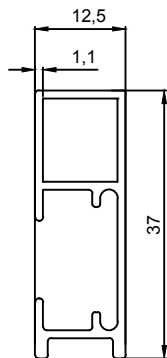

J 1253
0,308 Kg/m

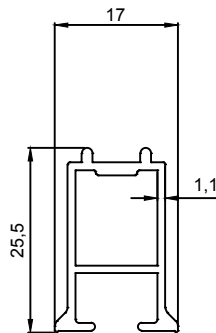

J 1255
0,262 Kg/m

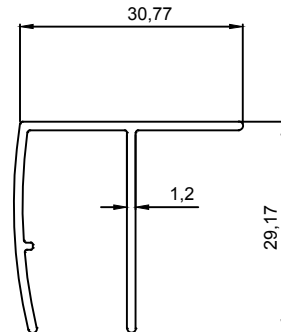

J 1871
284,90 Kg/m

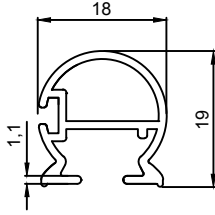

J 1251
0,240 Kg/m

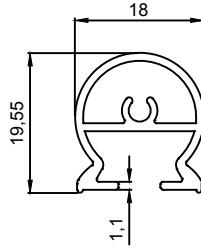

J 1252
0,254 Kg/m

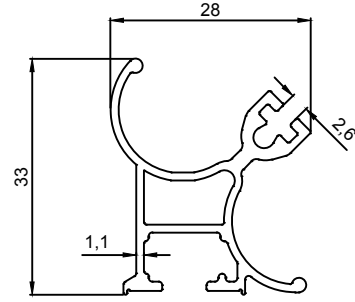

J 1254
0,418 Kg/m

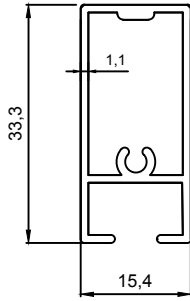

J 1256
0,338 Kg/m

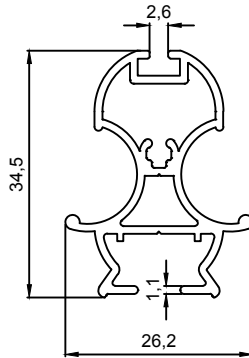

J 1257
0,443 Kg/m

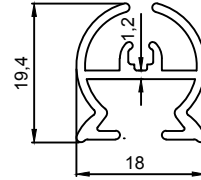

J 1258
0,267 Kg/m

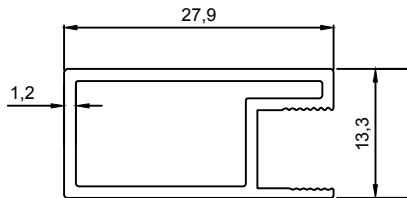

J 1872
0,271 Kg/m

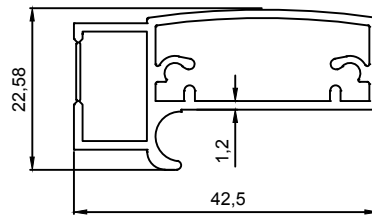

J 1873
0,492 Kg/m

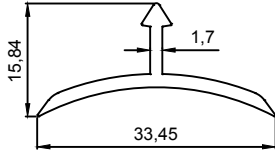

J 1091
0,217 Kg/m

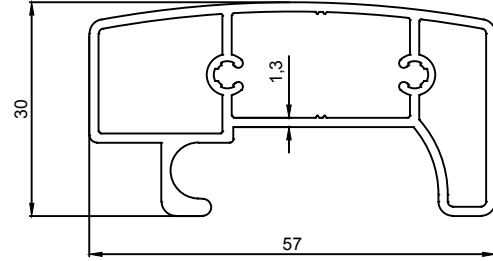

J 2087
0,797 Kg/m

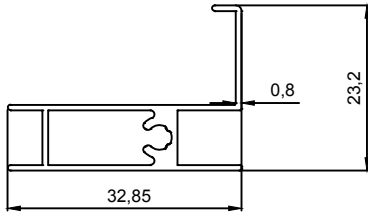

J 1104
0,255 Kg/m

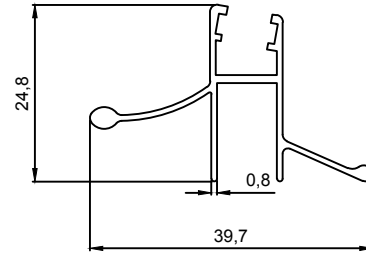

J 1105
0,238 Kg/m

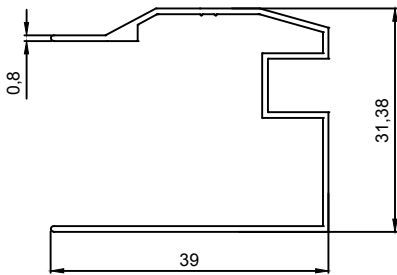

J 1106
0,282 Kg/m

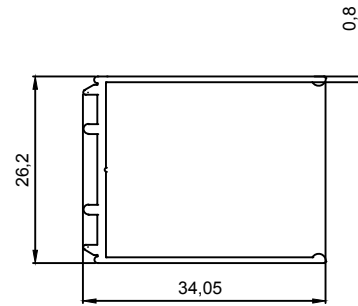

J 1107
0,249 Kg/m

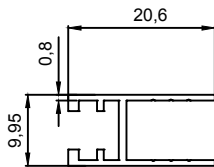

J 1108
0,133Kg/m

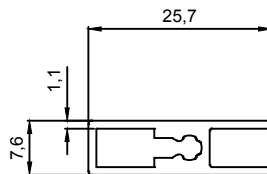

J 1109
0,233 Kg/m

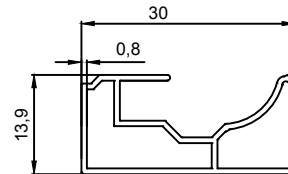

J 1110
0,230Kg/m